

# HIVE

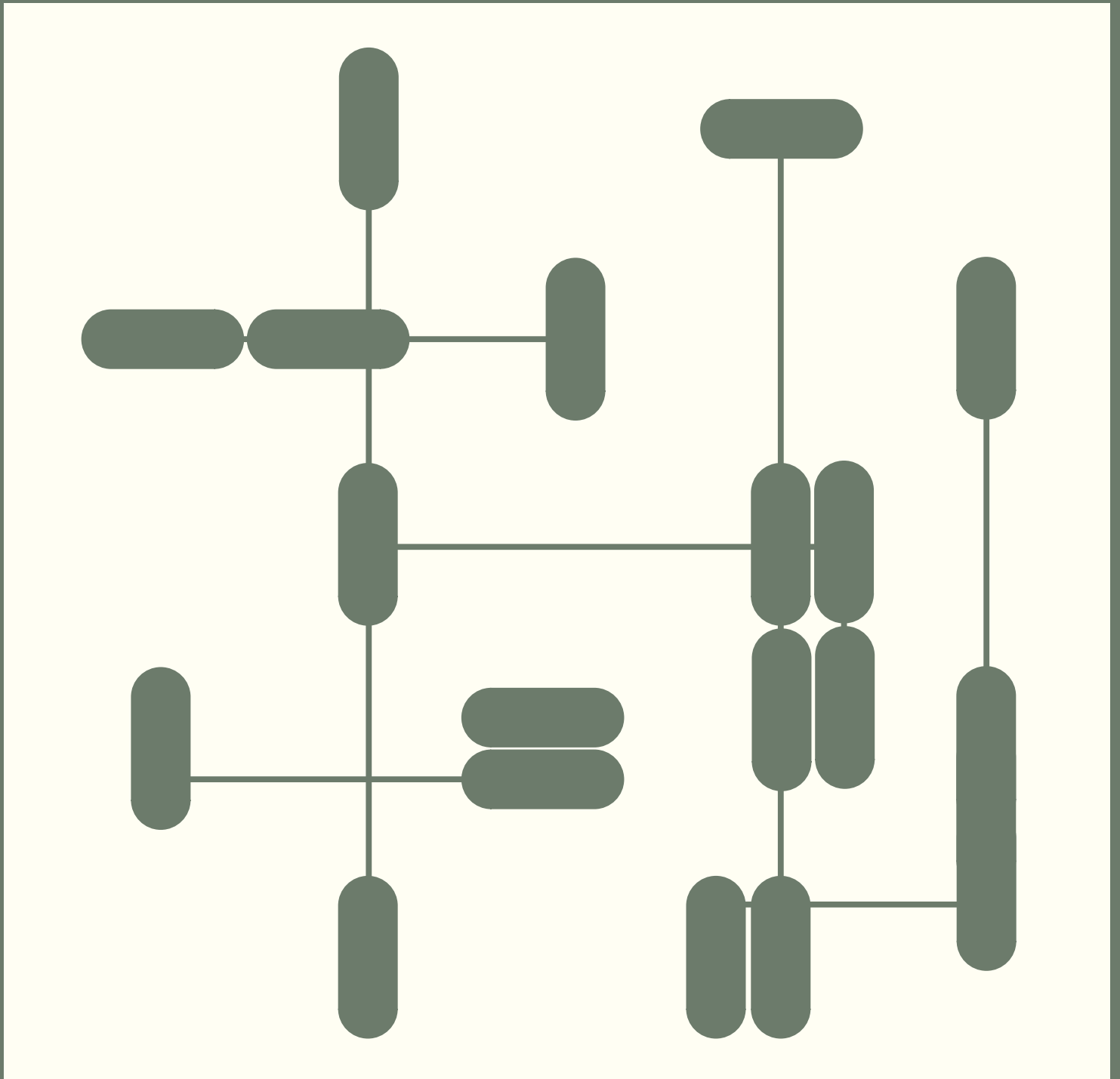

PRODUCT  
CATALOGUE

Office Collection

HAN

# HIVE

# MEET THE MODERN WORKSPACE

There is no single workspace that works for every organisation. The modern workspace is made up of adaptable spaces, uniquely catering to both the individual and the organisation. The HIVE collection has been designed with this in mind. Each product is versatile, providing solutions for multiple types of users.



The pandemic has shifted how work takes place. Since this, Australian employees have changed what they want within their workspaces.

According to a study, these are the top five wants from employees post-pandemic.



The static workspaces of the past aren't meeting these needs. The HIVE Collection responds to these needs and fills these gaps.

When designing for the modern workspace, research shows that these needs must be met.

THE GROUP  
AND THE  
INDIVIDUAL

Both individual workspaces and collaborative areas need to be able to coexist alongside one another.

THE STATIC  
AND THE  
MOBILE

In the past, workspaces were fixed structures. To be more efficient, workspaces now need to be able to become fluid if need be.

THE PRIVATE  
AND THE  
SOCIAL

The desire for enclosed personal spaces and open collaborative spaces allows for safety and flexibility.

THE  
INTEGRATION  
OF  
TECHNOLOGY

Both digital and physical work styles need to be able to coexist for there to be an efficient blending of these two work modes.

# HIVE Collection





The HIVE collection addresses the needs of the modern workspace, seamlessly blending the static and the mobile.

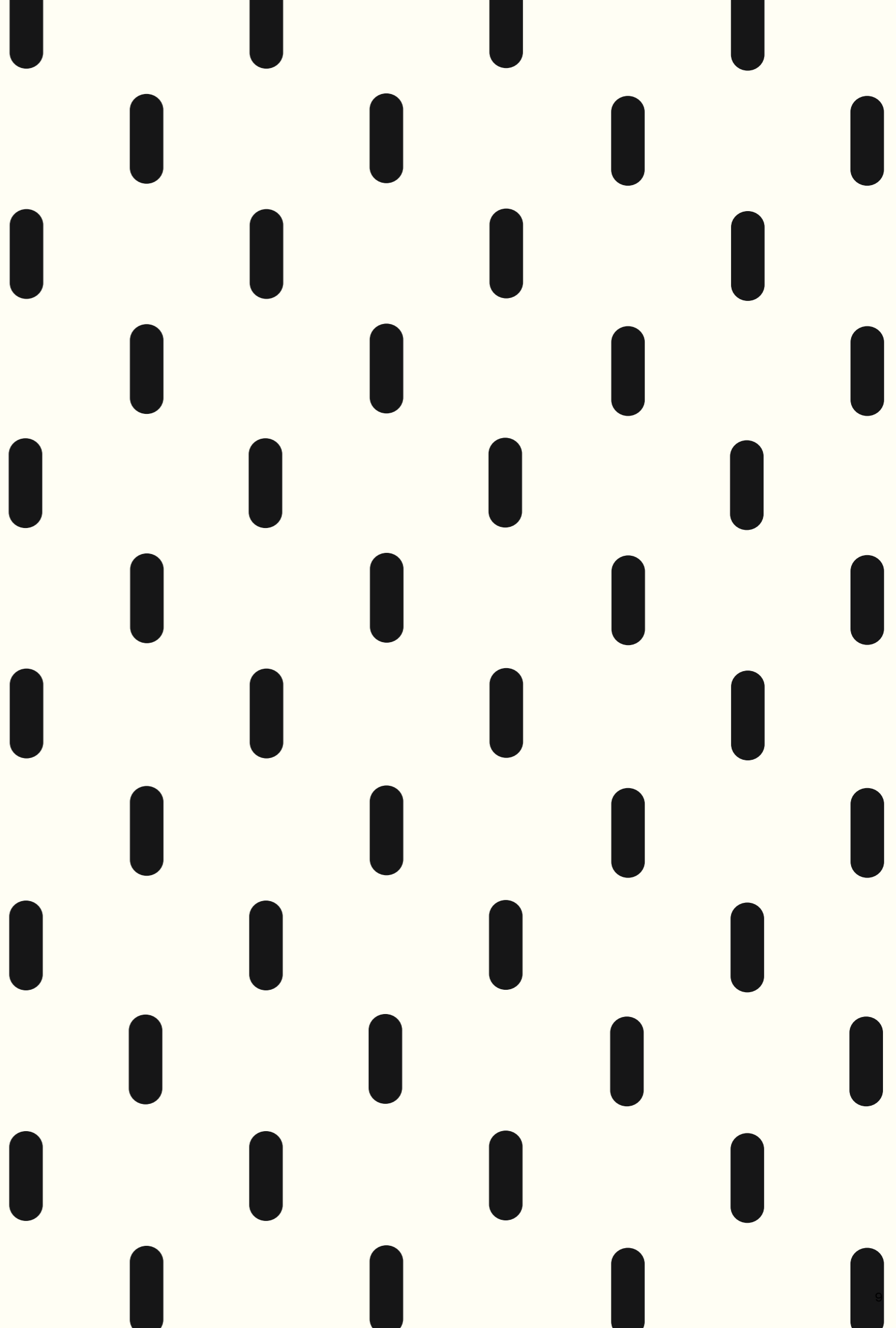

HIVE  
OFFICE COLLECTION



# OFFICE

## HIVE Sectors

The HIVE collection has been designed to fulfill the needs of the three main workspace sectors.

The three sectors have vastly different needs and yet each product can be customised to suit these various needs.

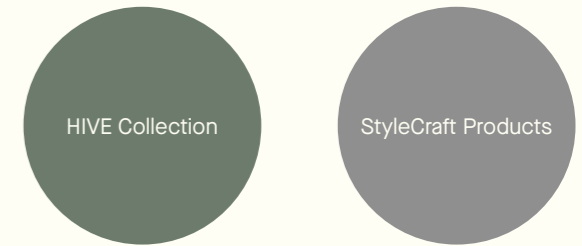

CORPORATE - HIVE COLLECTION

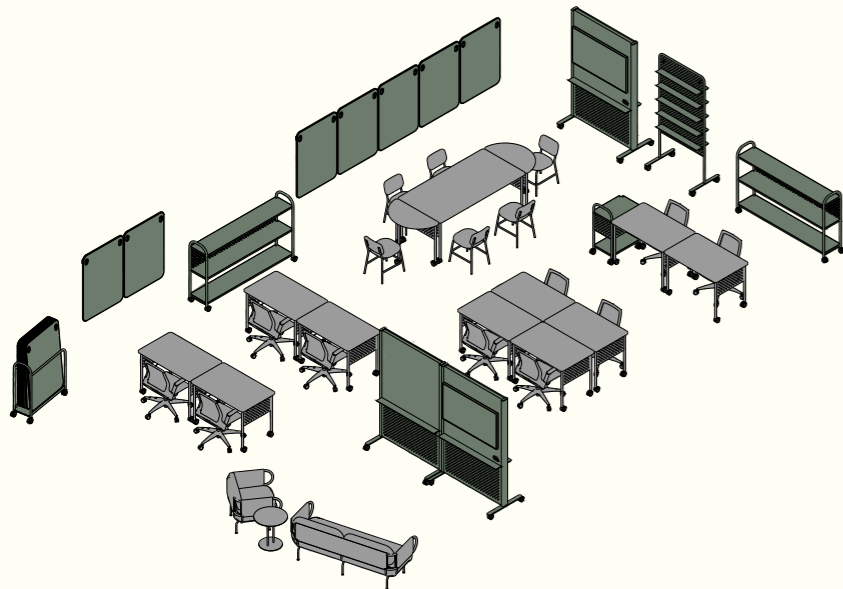

Base for functional teams. Assembled for individual focus and collaborative needs.

EDUCATION - HIVE COLLECTION

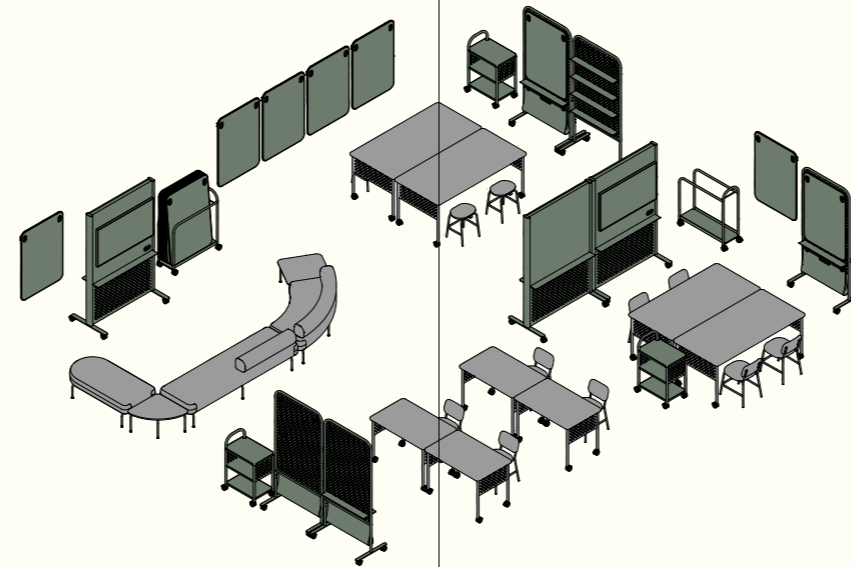

High traffic, agile methodologies with constantly changing user groups and workspaces.

CREATIVE - HIVE COLLECTION

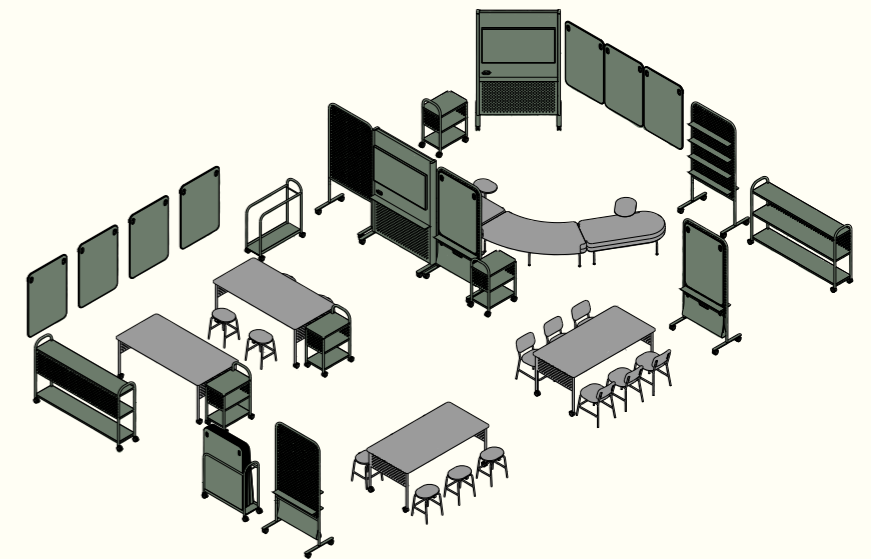

High collaboration and interaction. Creative teams practicing design thinking and consistent communication with high foot traffic



HIVE  
OFFICE COLLECTION



Power integrated within the Creative



HIVE  
OFFICE COLLECTION

Powdercoated steel detailing

HIVE  
OFFICE COLLECTION



All accessories can easily  
be hooked onto the HIVE  
mesh wall







## HIVE - Modularity

Designed to be easily customised for any project. Ordering HIVE is intuitive and flexible, alternatively you can select from one of our predefined bundles.

HIVE ACCESSORIES

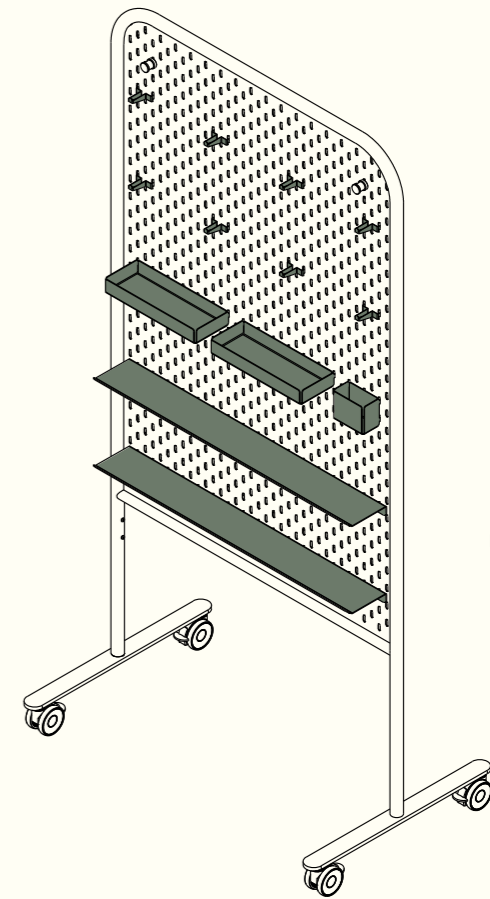
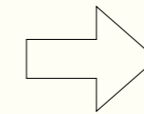
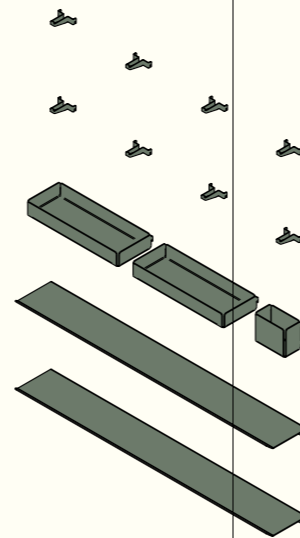
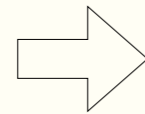
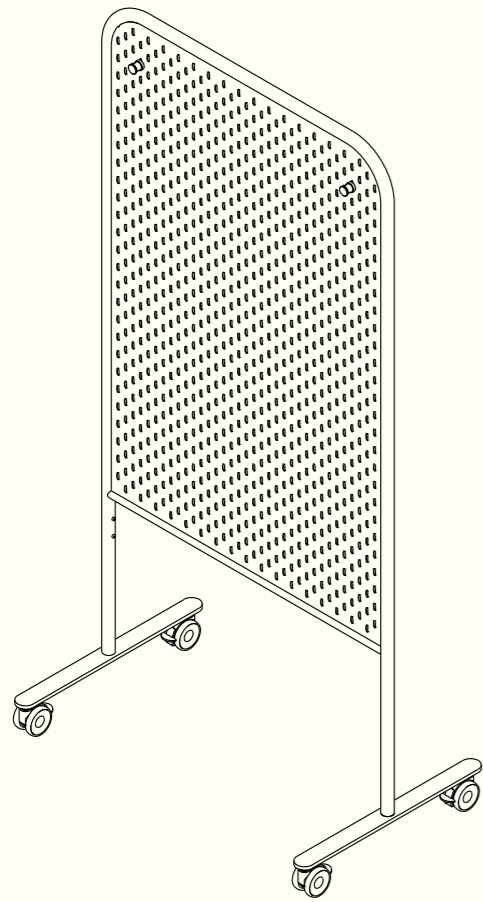

### PICK - HIVE CORE PRODUCT

Select from a range of core products. These mobile structures allow for the attachment of a range of unique accessories.

### SELECT - HIVE ACCESSORIES

Now select from a range of accessories. Including storage, whiteboards, pinboards, shelving and power.

### COMBINE - ASSEMBLE TOGETHER

Combine all into a unique configuration or specify a predefined bundle.

## HIVE Traveller

HIVE COLLECTION – MAY 2022  
CODE: HI\_TVR\_101

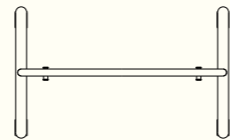
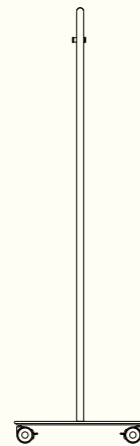
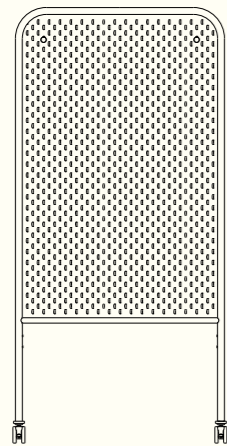
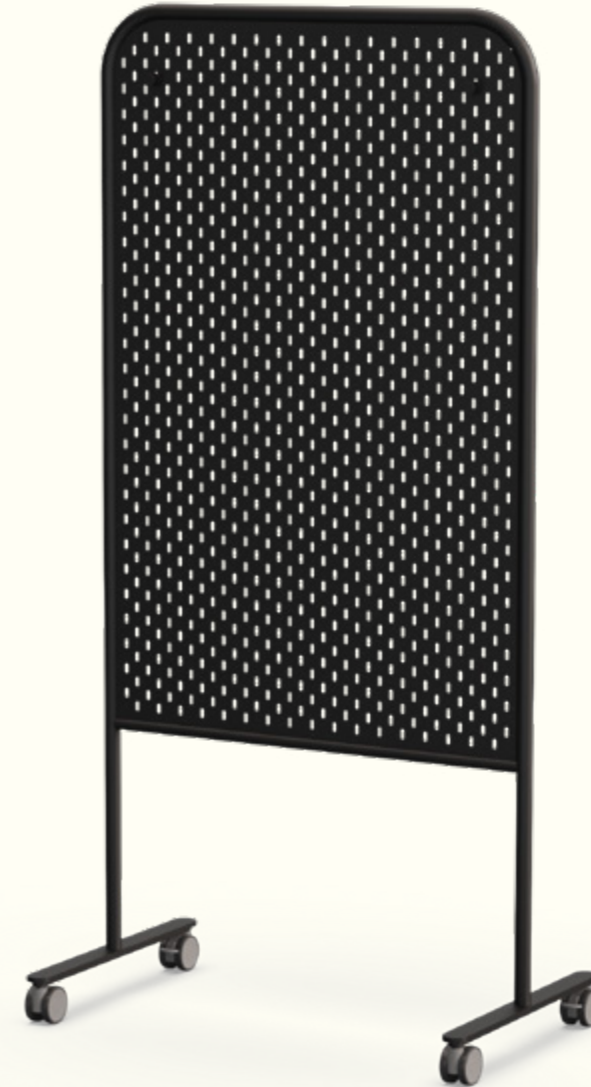
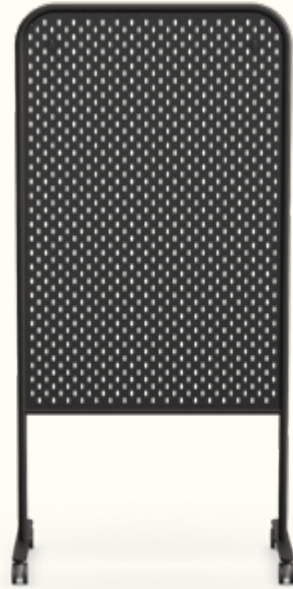

### DETAILS

The HIVE Traveller is a modular pegboard which has the ability to be customised to suit the needs of any workspace. The HIVE mesh system has been specifically built to suit industry mounts such as the VESA mount and also to cater to the various HIVE collection accessories that are available alongside this product.

### DIMENSIONS

980mm W / 600mm D / 2000mm H

### FRAME



Black Texture   Shale Grey Matt   Deep Ocean Texture   Manor Red Matt   Wilderness Green Matt

### FABRIC



InStyle Ecoustic Felt Fabric

### ACCESSORIES

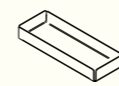

HIVE Low Tub

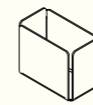

HIVE Pen Holder

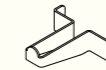

HIVE Hook

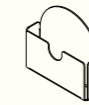

HIVE Power Tub



HIVE Traveller Duo Panel Whiteboard / Pinboard



HIVE Traveller Fabric Bag

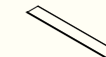

HIVE Traveller Shelf



HIVE Power Tub

MADE IN AUSTRALIA.  
8 WEEK LEAD TIME.  
5 YEAR STRUCTURAL WARRANTY.

## HIVE - Modularity

The HIVE Traveller has been designed to work within multiple settings and with vastly differing users. The HIVE Traveller bundles have been designed with these different users in mind, providing starter packs for easy specification.

Select Front and Back Face Bundles

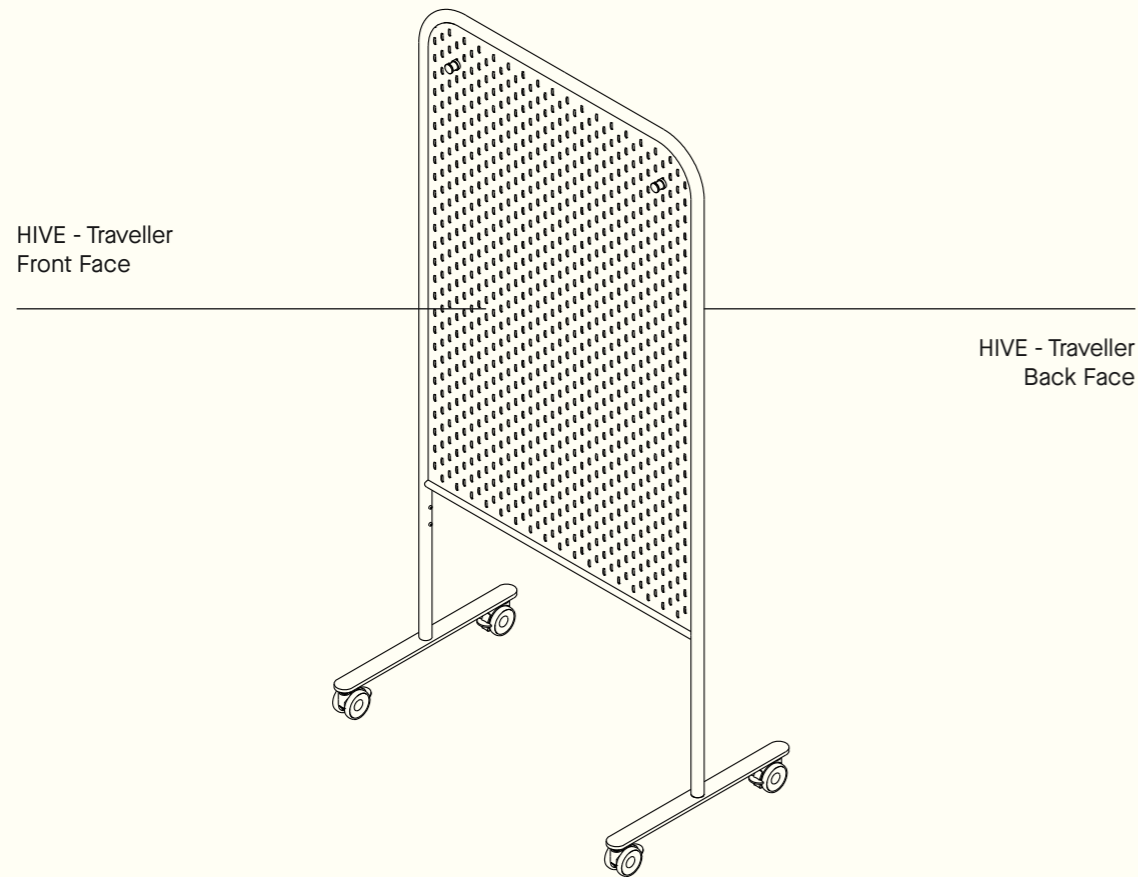

## HIVE - Face Bundles

EACH TRAVELLER HAS TWO FACES AVAILABLE PER FRAME

HIVE COLLECTION - MAY 2022

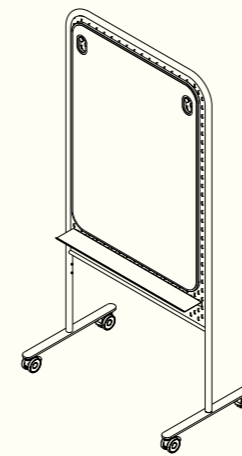

Product Code: HI\_TVR\_Scribe

### Traveller - Scribe

- 1 x HIVE Traveller Duo Panel
- 1 x HIVE Traveller Shelf

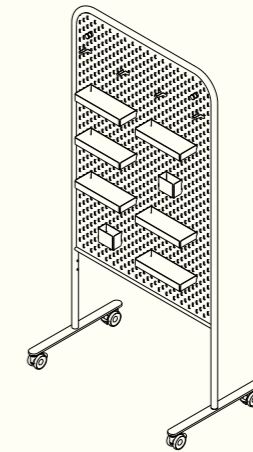

Product Code: HI\_TVR\_Storage

### Traveller - Storage

- 6 x HIVE Low Tub
- 2 x HIVE Pen Holder
- 4 x HIVE Hook

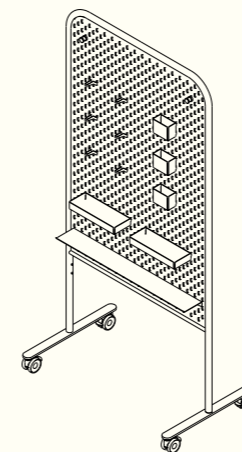

Product Code: HI\_TVR\_Flex

### Traveller - Flex

- 1 x HIVE Traveller Shelf
- 2 x HIVE Low Tub
- 3 x HIVE Pen Holder
- 6 x HIVE Hook

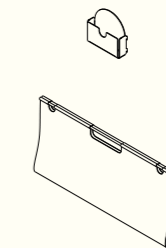

Pairing Accessories

### HIVE - Accessories

- HIVE Traveller Fabric Bag
- HIVE Power Tub

## HIVE - Traveller Deluxe Package

The HIVE Traveller Deluxe has been assembled to support a diverse range of applications. A premium solution for an ever changing environment.

### Traveller - Deluxe Package

#### Side A:

- 1 x HIVE Traveller Duo Panel
- 1 x HIVE Traveller Shelf
- 2 x HIVE Hook
- 1 x HIVE Traveller Fabric Bag

#### Side B:

- 2 x HIVE Traveller Shelf
- 1 x HIVE Pen Holder
- 2 x HIVE Low Tub
- 8 x HIVE Hook

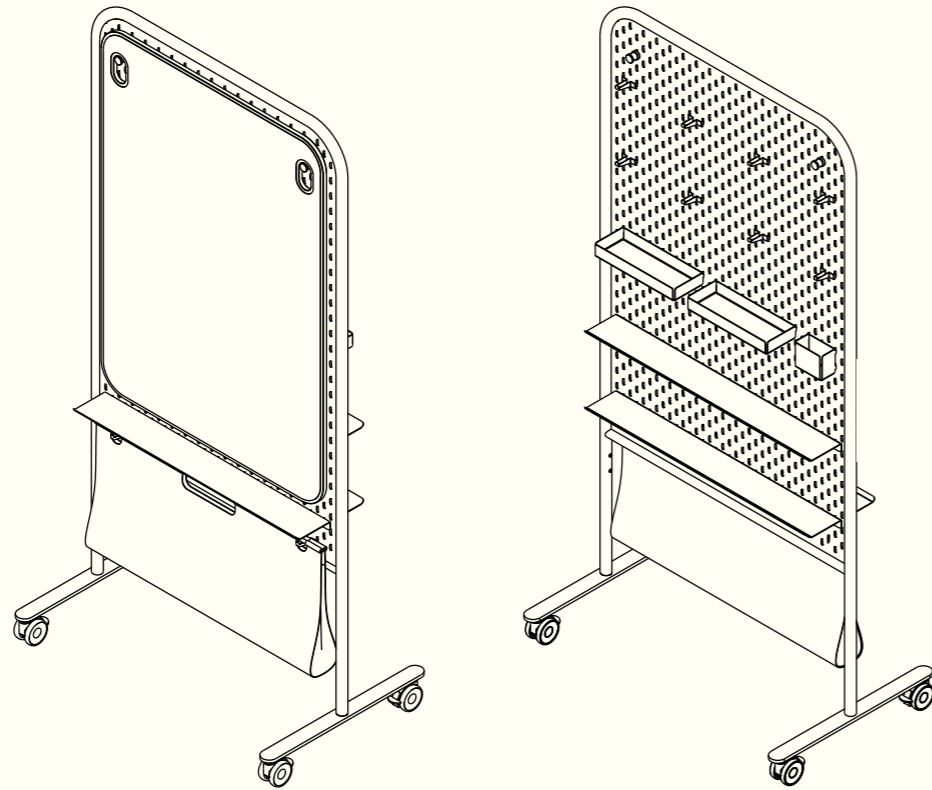

Product Code: HI\_TVR\_DELUXE

## HIVE - Start Up Package

The HIVE starter pack offers an easy and intuitive group of products for specification.

HIVE COLLECTION - MAY 2022  
Package Code: HI\_START\_PCK

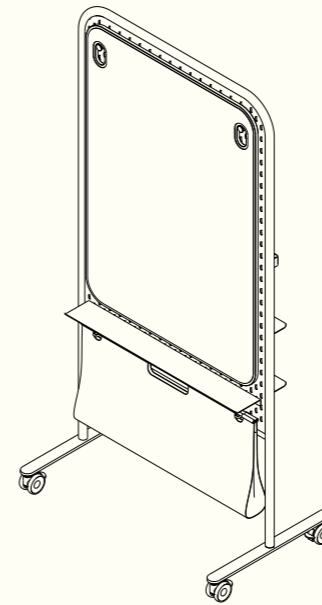

1 x HIVE Traveller - Deluxe Package

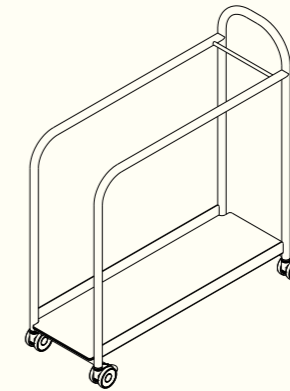

1 x HIVE Traveller Trolley

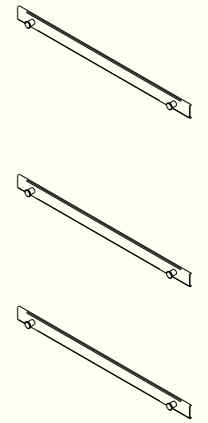

3 x HIVE Wall Mount

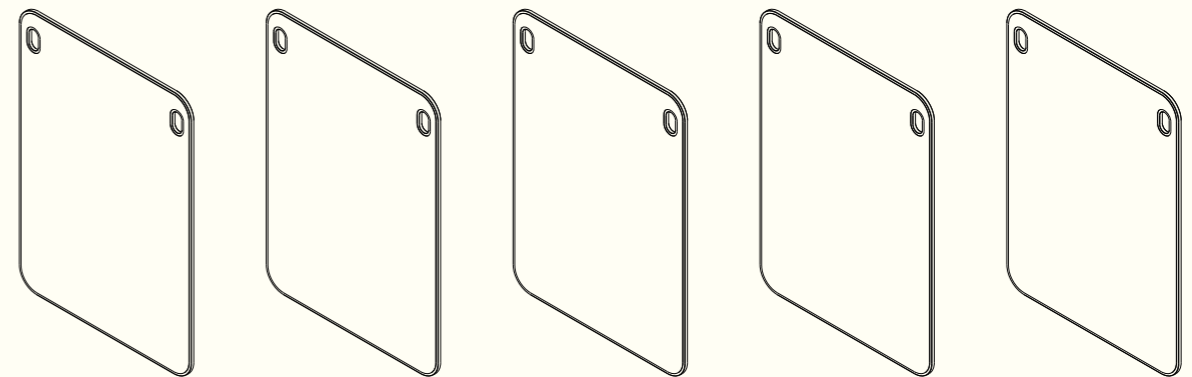

5 x HIVE Duo Panel

## HIVE Canvas

HIVE COLLECTION – MAY 2022  
CODE: HI\_CAN\_601

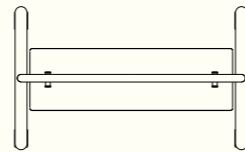
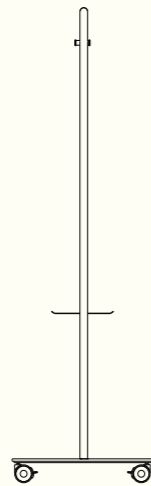
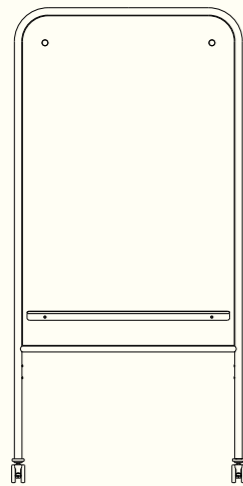
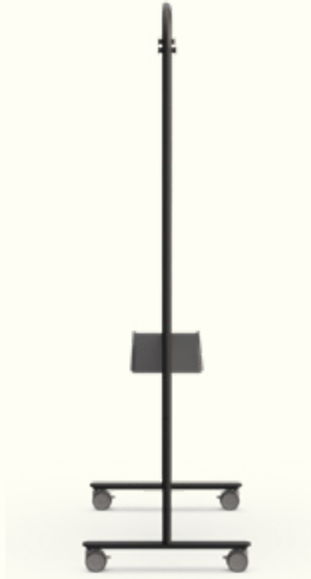
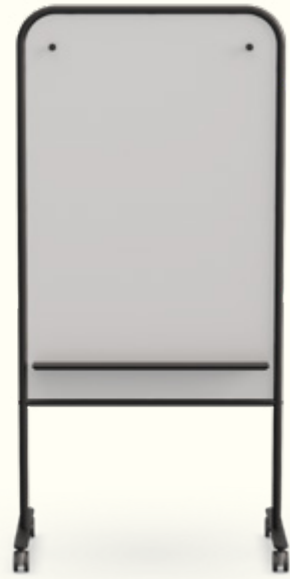

### DETAILS

The HIVE Canvas is a mobile whiteboard that can integrate into any work environment. The HIVE Canvas pairs with the HIVE collection to create flexible work environments. The swivel castors allow for the white board unit to easily be moved into different areas of the workspace and to then become stationary with the use of the braking mechanism.

### DIMENSIONS

980mm W / 600mm D / 2000mm H

### FRAME



### ACCESSORIES



HIVE Duo Panel

MADE IN AUSTRALIA.  
8 WEEK LEAD TIME.  
5 YEAR STRUCTURAL WARRANTY.



# OFFICE

## HIVE Creative + Power

HIVE COLLECTION - MAY 2022  
CODE: HI\_CRA\_201

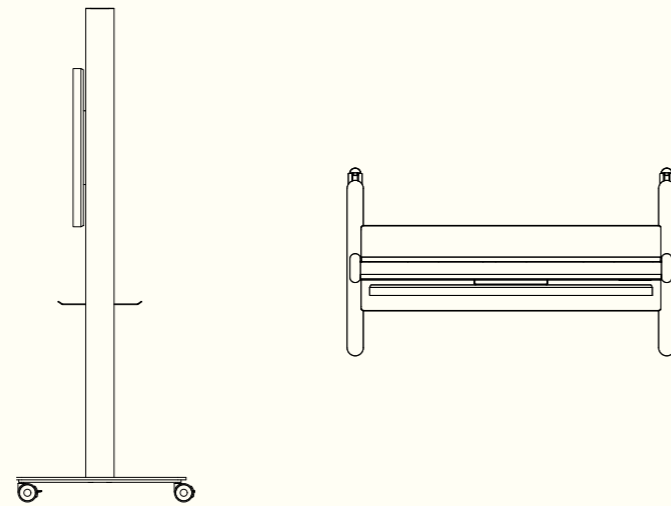
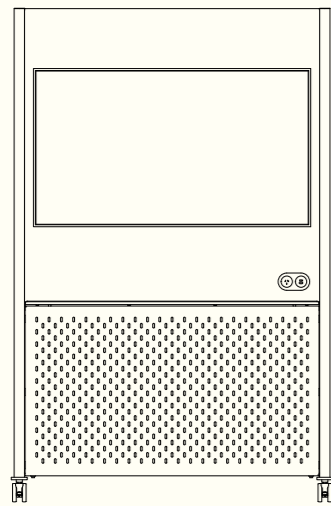

### DETAILS

The HIVE Creative is a complete mobile workstation solution for the ever changing workspace - featuring a large whiteboard, universal VESA TV mount, integrated power and USB C charging. The HIVE Creative incorporates the HIVE mesh grid system, allowing for a range of unique accessories to be attached.

### DIMENSIONS

1300mm W / 750mm D / 2000mm H

### FRAME

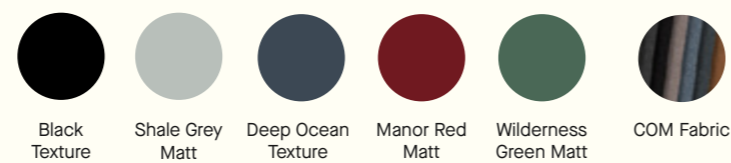

### FABRIC

### ACCESSORIES

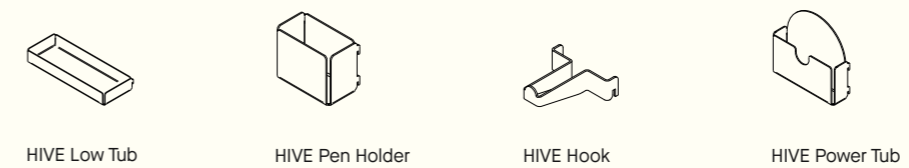

\*TV not included  
We recommend mounting Tv's 50" and under.

MADE IN AUSTRALIA.  
8 WEEK LEAD TIME.  
5 YEAR STRUCTURAL WARRANTY.

## HIVE Lectern

HIVE COLLECTION - APRIL 2024  
CODE: HI\_LEC\_901

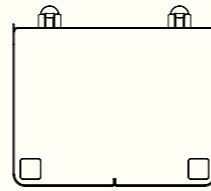
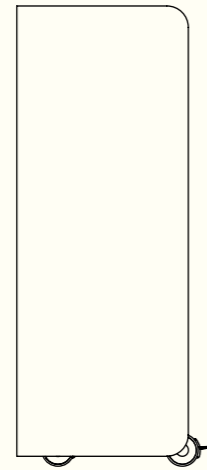
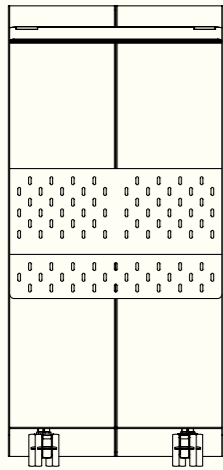

### DETAILS

The HIVE Lectern is a mobile presentation lectern solution for the ever changing workspace. The HIVE Lectern incorporates the HIVE mesh grid system, allowing for a range of unique accessories to be attached.

### DIMENSIONS

500mm W / 400mm D / 1074mm H

### FRAME



### ACCESSORIES

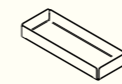

HIVE Low Tub

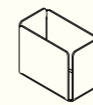

HIVE Pen Holder

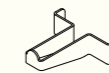

HIVE Hook

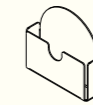

HIVE Power Tub

MADE IN AUSTRALIA.  
8 WEEK LEAD TIME.  
5 YEAR STRUCTURAL WARRANTY.

## HIVE Messenger

HIVE COLLECTION – MAY 2022  
CODE: HI\_MES\_301

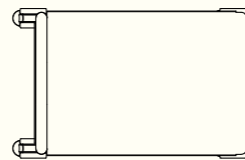
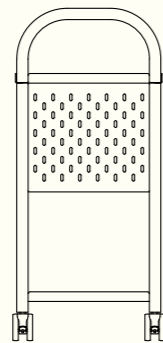
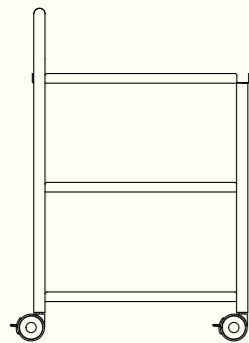

### DETAILS

The HIVE Messenger features the same mesh system as the rest of the HIVE collection. It perfectly accompanies the Traveller, adding versatile storage. The swivel castors allow for the shelving unit to easily be moved into different areas of the workspace and to then become stationary with the use of the braking mechanism.

### DIMENSIONS

610mm W / 410mm D / 850mm H

### FRAME



### ACCESSORIES

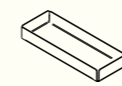

HIVE Low Tub

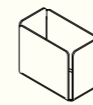

HIVE Pen Holder

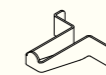

HIVE Hook

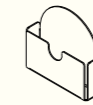

HIVE Power Tub

MADE IN AUSTRALIA.  
8 WEEK LEAD TIME.  
5 YEAR STRUCTURAL WARRANTY.

## HIVE Mobile Shelf

HIVE COLLECTION – MAY 2022  
CODE: HI\_SLF\_401

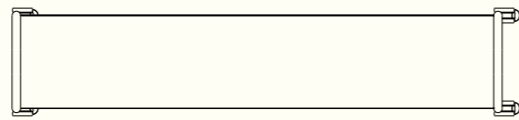
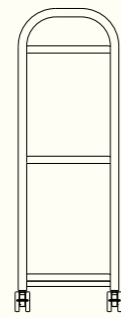
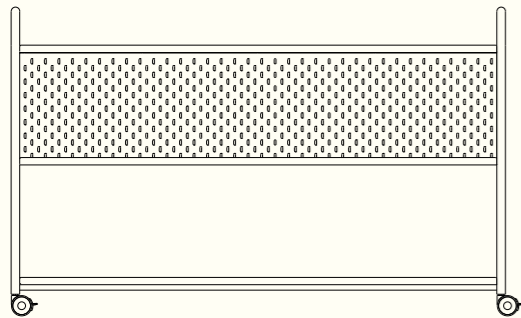
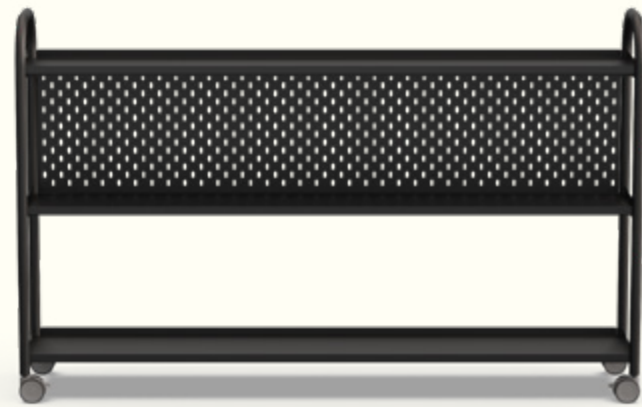

### DETAILS

The HIVE Mobile Shelf features the same mesh system as the rest of the HIVE collection. It perfectly accompanies the Traveller, allowing for further versatility as a storage solution. The swivel castors allow for the shelving unit to easily be moved into different areas of the workplace and to then become stationary with the use of the braking mechanism.

### DIMENSIONS

1840mm W / 390mm D / 1150mm H

### FRAME



### ACCESSORIES

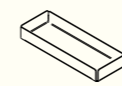

HIVE Low Tub

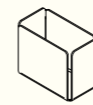

HIVE Pen Holder

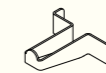

HIVE Hook



HIVE Power Tub

MADE IN AUSTRALIA.  
8 WEEK LEAD TIME.  
5 YEAR STRUCTURAL WARRANTY.

## HIVE Traveller Trolley

HIVE COLLECTION – MAY 2022  
CODE: HI\_TVR\_TRL\_102

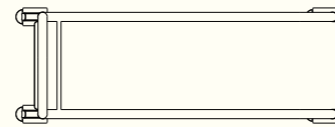
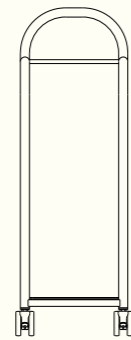
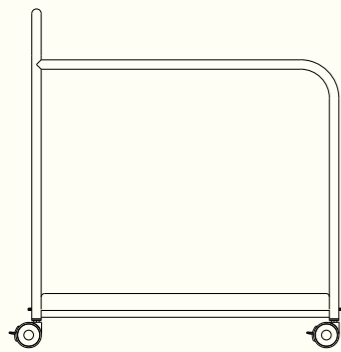

### DETAILS

The HIVE Traveller Trolley accompanies the HIVE Traveller to provide mobile storage for the HIVE Traveller Duo Panel Whiteboard / Pinboard accessory. This allows for multiple whiteboards to be easily moved, stored and accessed. Built from tubular steel, this creates a sturdy frame for the whiteboards to sit within. The swivel castors have a braking mechanism, allowing the cart to be secure when stationary.

### DIMENSIONS

1010mm W / 330mm D / 830mm H

### FRAME



Black  
Texture

Shale Grey  
Matt

Deep Ocean  
Texture

Manor Red  
Matt

Wilderness  
Green Matt

MADE IN AUSTRALIA.  
8 WEEK LEAD TIME.  
5 YEAR STRUCTURAL WARRANTY.



## HIVE Wall Mount

HIVE COLLECTION – MAY 2022  
CODE: HI\_WL\_MT\_501

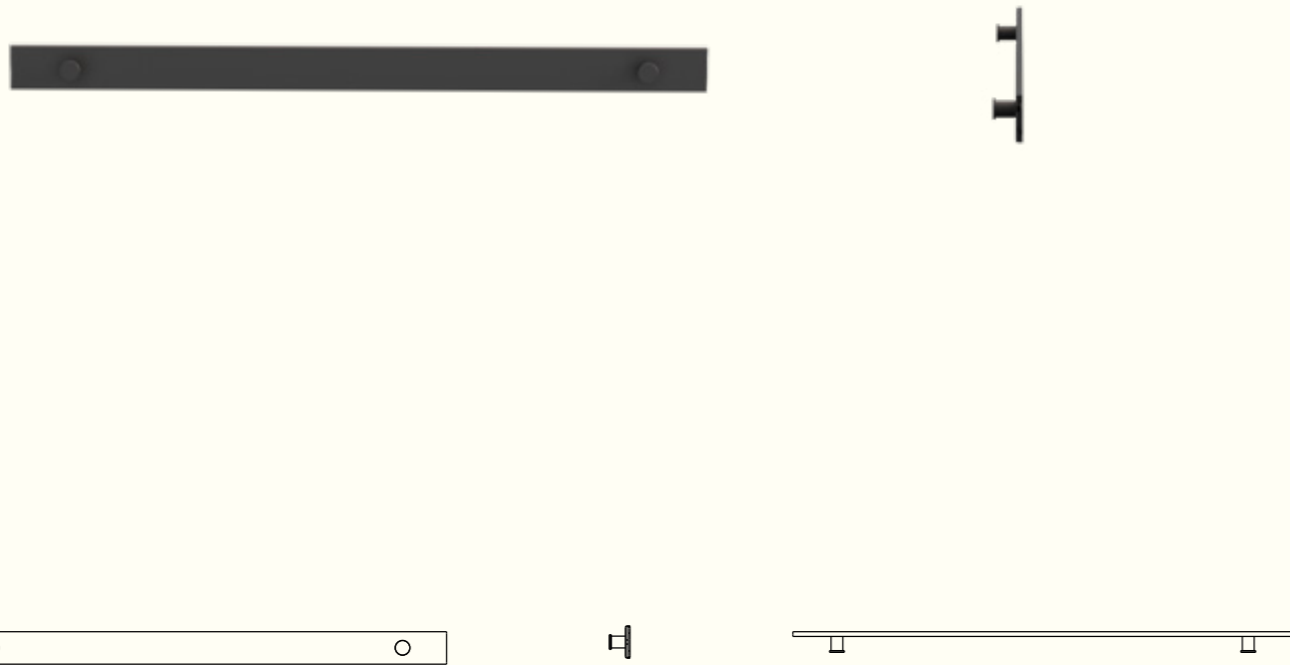

### DETAILS

The HIVE Wall Mount creates a functional and organised workspace. Capable of holding multiple HIVE writing surfaces, switching them out as needed.

### DIMENSIONS

850mm W / 35mm D / 55mm H

### FRAME



### ACCESSORIES



HIVE Duo Panel



HIVE Lightweight Whiteboard

MADE IN AUSTRALIA.  
8 WEEK LEAD TIME.  
5 YEAR STRUCTURAL WARRANTY.

## HIVE Traveller Duo Panel

HIVE COLLECTION – MAY 2022  
CODE: HI\_TVR\_DUO\_PNL\_103

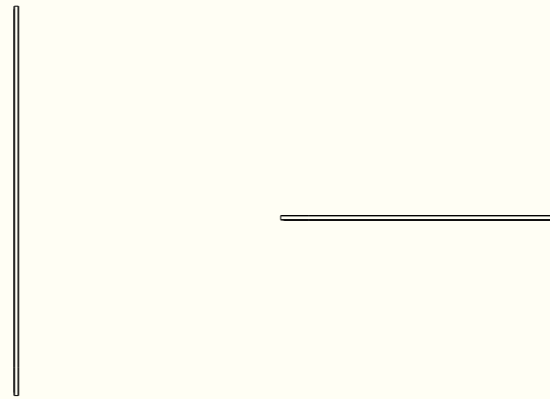
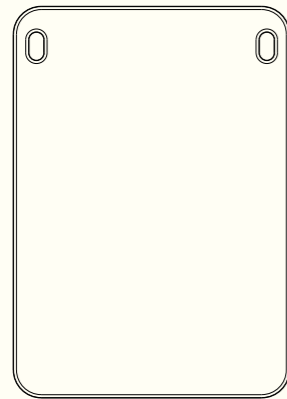
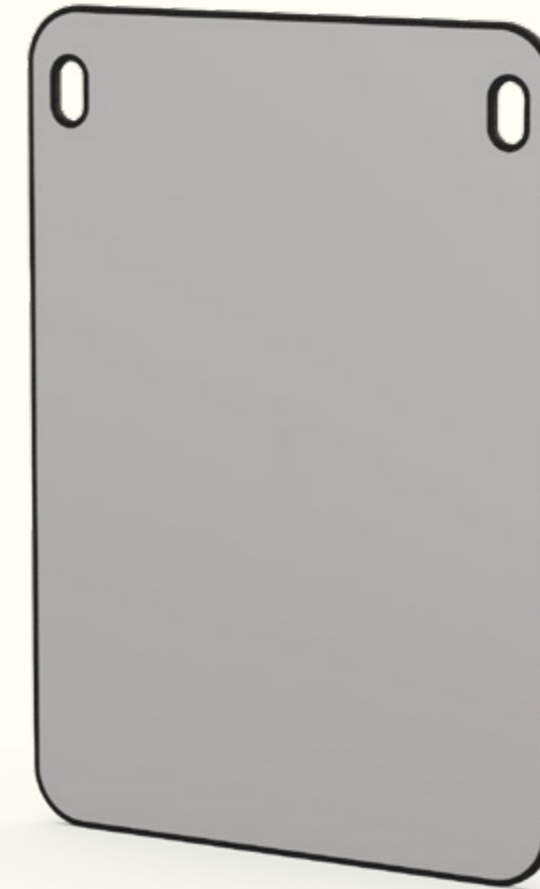
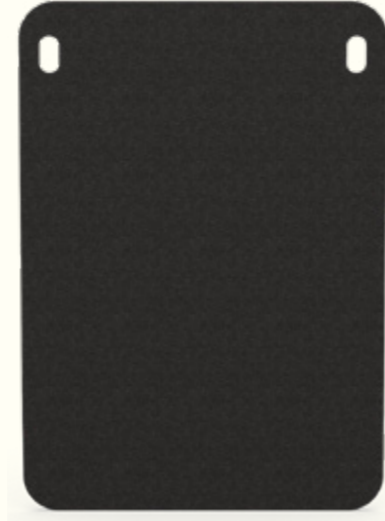
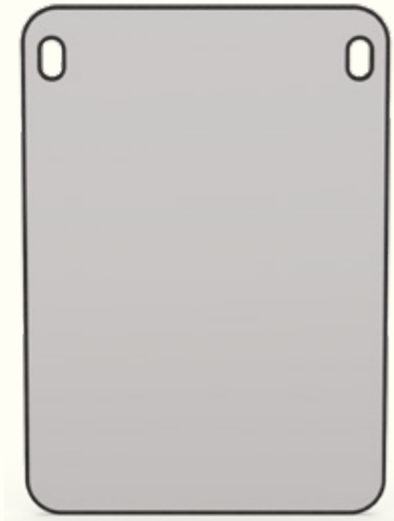

### DETAILS

The HIVE Traveller Duo Panel Whiteboard / Pinboard is a multi use pinboard and magnetic Whiteboard. Easily hung on a HIVE Wall Mount or HIVE Traveller and stored within the HIVE Traveller Trolley.

### DIMENSIONS

850mm W / 15mm D / 1190mm H

### FRAME

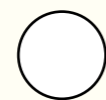

Whiteboard  
White

### FABRIC



InStyle Ecoustic  
Felt Fabric

### ACCESSORIES



HIVE Wall Mount

MADE IN AUSTRALIA.  
8 WEEK LEAD TIME.  
5 YEAR STRUCTURAL WARRANTY.

## HIVE Lightweight Whiteboard

HIVE COLLECTION – MAY 2022  
CODE: HI\_TRV\_LW\_WB\_105

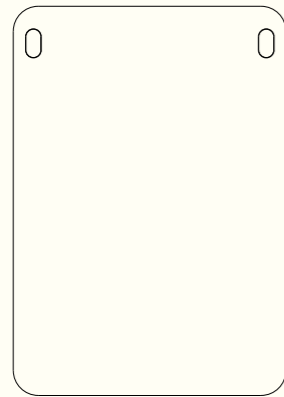

### DETAILS

The HIVE Scribe is a lightweight double-sided whiteboard. Hang multiple on a HIVE Wall Mount or HIVE Traveller and stored within the HIVE Traveller Trolley. The HIVE Scribe can be printed on for further customisation.

### DIMENSIONS

850mm W / 3.2mm D / 1190mm H

### FRAME

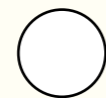

Whiteboard  
White

### ACCESSORIES

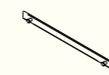

HIVE Wall Mount

MADE IN AUSTRALIA.  
8 WEEK LEAD TIME.  
5 YEAR STRUCTURAL WARRANTY.

## HIVE Pen Holder

HIVE COLLECTION – MAY 2022  
CODE: HI\_PN\_HLD\_702

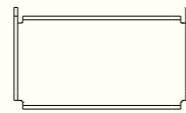
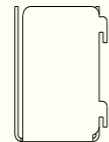
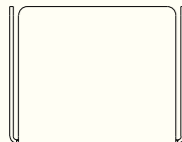

### DETAILS

The HIVE Pen Holder can be attached to the HIVE mesh system allowing for the storage of numerous smaller items needed within a workspace environment. The Pen Holder is made from powder coated sheet steel allowing for cohesion with the rest of the collection.

### DIMENSIONS

100mm W / 60mm D / 80mm H

### FRAME



MADE IN AUSTRALIA.  
8 WEEK LEAD TIME.  
5 YEAR STRUCTURAL WARRANTY.

## HIVE Low Tub

HIVE COLLECTION – MAY 2022  
CODE: HI\_LW\_TB\_701

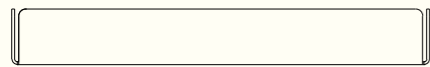
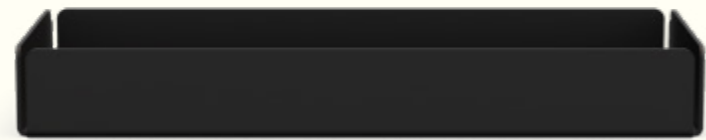

### DETAILS

The HIVE Low Tub can be attached to the HIVE mesh system becoming a versatile storage solution for the modern workspace. The Low Tub is built from powder coated sheet steel allowing for cohesion with the rest of the collection.

### DIMENSIONS

300mm W / 115mm D / 40mm H

### FRAME



Black  
Texture

Shale Grey  
Matt

Deep Ocean  
Texture

Manor Red  
Matt

Wilderness  
Green Matt

MADE IN AUSTRALIA.  
8 WEEK LEAD TIME.  
5 YEAR STRUCTURAL WARRANTY.



## HIVE Power Tub

HIVE COLLECTION – MAY 2022  
CODE: HI\_PWR\_TB\_703

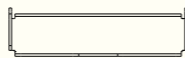
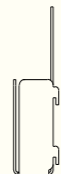
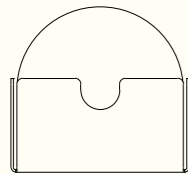

### DETAILS

The HIVE Power Tub can be attached to the HIVE mesh system allowing for the storage of the CMS Freedom Power Module. The Power Tub is made from powder coated sheet steel allowing for cohesion with the rest of the collection.

### DIMENSIONS

152mm W / 42mm D / 140mm H

### FRAME



MADE IN AUSTRALIA.  
8 WEEK LEAD TIME.  
5 YEAR STRUCTURAL WARRANTY.

## HIVE Hook

HIVE COLLECTION – MAY 2022  
CODE: HI\_HK\_801

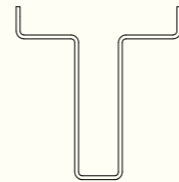
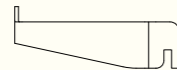
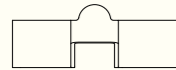
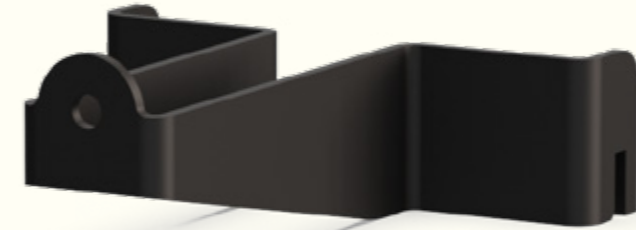

### DETAILS

The HIVE Hook is a custom hook design that seamlessly fits into the HIVE mesh wall system. The HIVE Hook allows for easy customisation of any HIVE mesh product, tailoring the HIVE range to suit both individual needs and different environments.

### DIMENSIONS

50mm W / 54mm D / 20mm H

### FRAME



MADE IN AUSTRALIA.  
8 WEEK LEAD TIME.  
5 YEAR STRUCTURAL WARRANTY.

## HIVE Traveller Fabric Bag

HIVE COLLECTION – MAY 2022  
CODE: HI\_TRV\_FB\_BG\_105

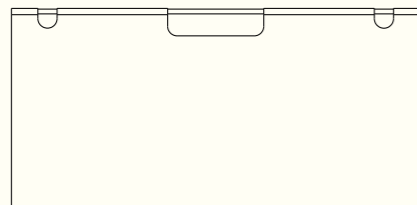

### DETAILS

A unique accessory to the HIVE Traveller, the HIVE fabric bag easily hooks onto the base of the mesh frame with the HIVE Hook and can carry multiple accessories, documents and supplies. Designed to be easily removed and used, creating a soft tactile aesthetic to the HIVE collection.

### DIMENSIONS

850mm W / 20mm D / 430mm H

### FRAME



Black  
Texture



Shale Grey  
Matt



Deep Ocean  
Texture



Manor Red  
Matt



Wilderness  
Green Matt

### FABRIC



InStyle  
Ecoustic Felt  
Fabric

MADE IN AUSTRALIA.  
8 WEEK LEAD TIME.  
5 YEAR STRUCTURAL WARRANTY.

## HIVE Traveller Shelf

HIVE COLLECTION – MAY 2022  
CODE: HI\_TVR\_SLF\_104

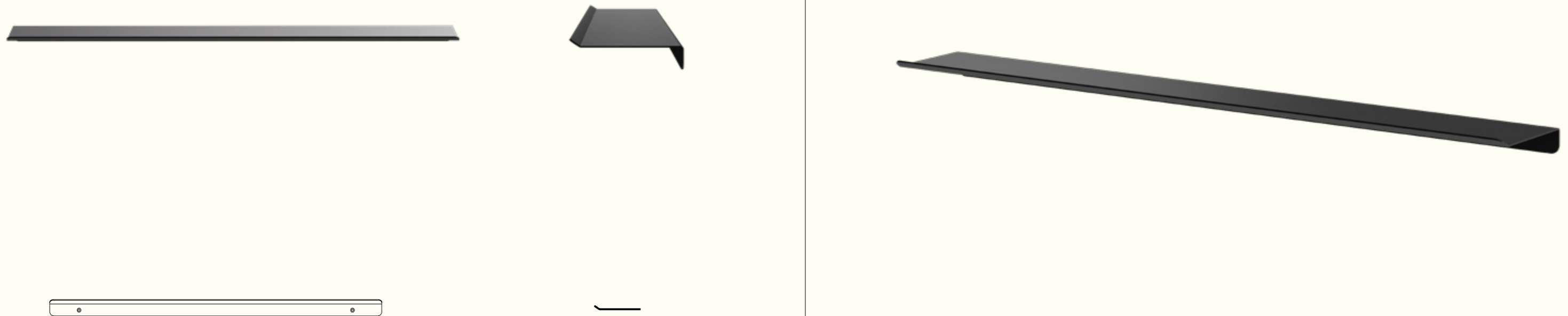

### DETAILS

The HIVE Traveller Shelf screws into the mesh frame of the HIVE Traveller and Canvas. It can be used to carry multiple accessories.

### DIMENSIONS

850mm W / 130mm D / 40mm H

### FRAME



MADE IN AUSTRALIA.  
8 WEEK LEAD TIME.  
5 YEAR STRUCTURAL WARRANTY.

## HIVE Canvas Whiteboard

HIVE COLLECTION – MAY 2022  
CODE: HI\_CAN\_WB\_602

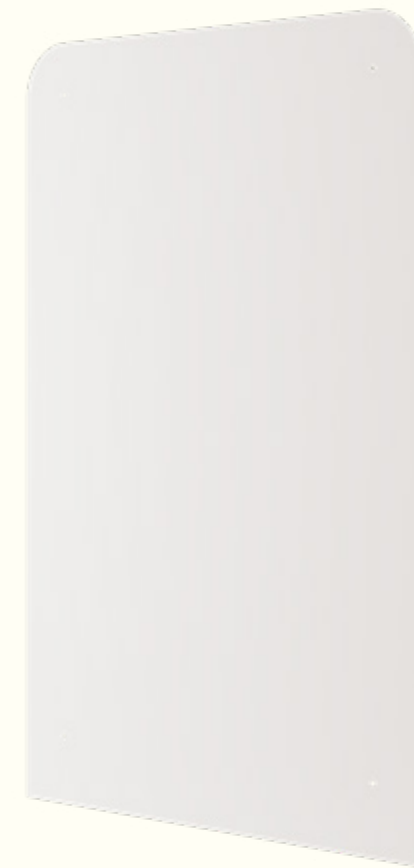
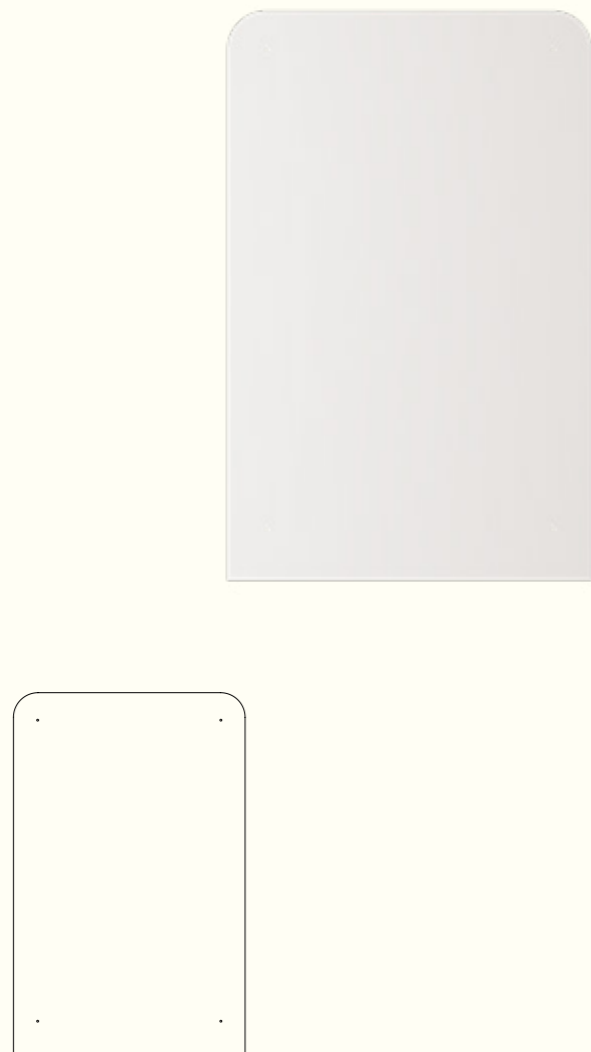

### DETAILS

The HIVE Canvas Whiteboard is a lightweight double-sided whiteboard. Screwed into the HIVE Traveller mesh wall. The HIVE Canvas Whiteboard can be printed on for further customisation.

### DIMENSIONS

1378mm W / 885mm D / 1mm H

### FRAME



Black  
Texture



Shale Grey  
Matt



Deep Ocean  
Texture



Manor Red  
Matt



Wilderness  
Green Matt



InStyle  
Ecoustic Felt  
Fabric

### FABRIC

MADE IN AUSTRALIA.  
8 WEEK LEAD TIME.  
5 YEAR STRUCTURAL WARRANTY.





## HIVE Sector - Corporate

### HIVE SECTOR - CORPORATE

Base for functional teams. Assembled for individual focus and collaborative needs.

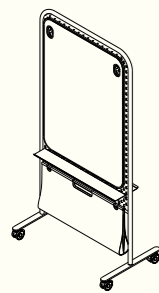

HIVE Traveller

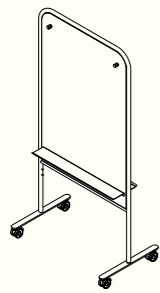

HIVE Canvas

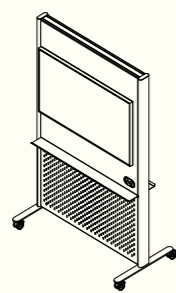

HIVE Creative



HIVE Messenger

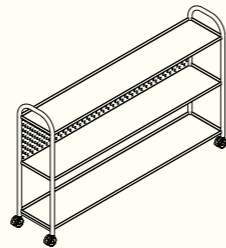

HIVE Mobile

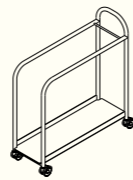

HIVE Traveller Trolley

### HIVE SECTOR - CORPORATE INDEX

#### Configuration Index

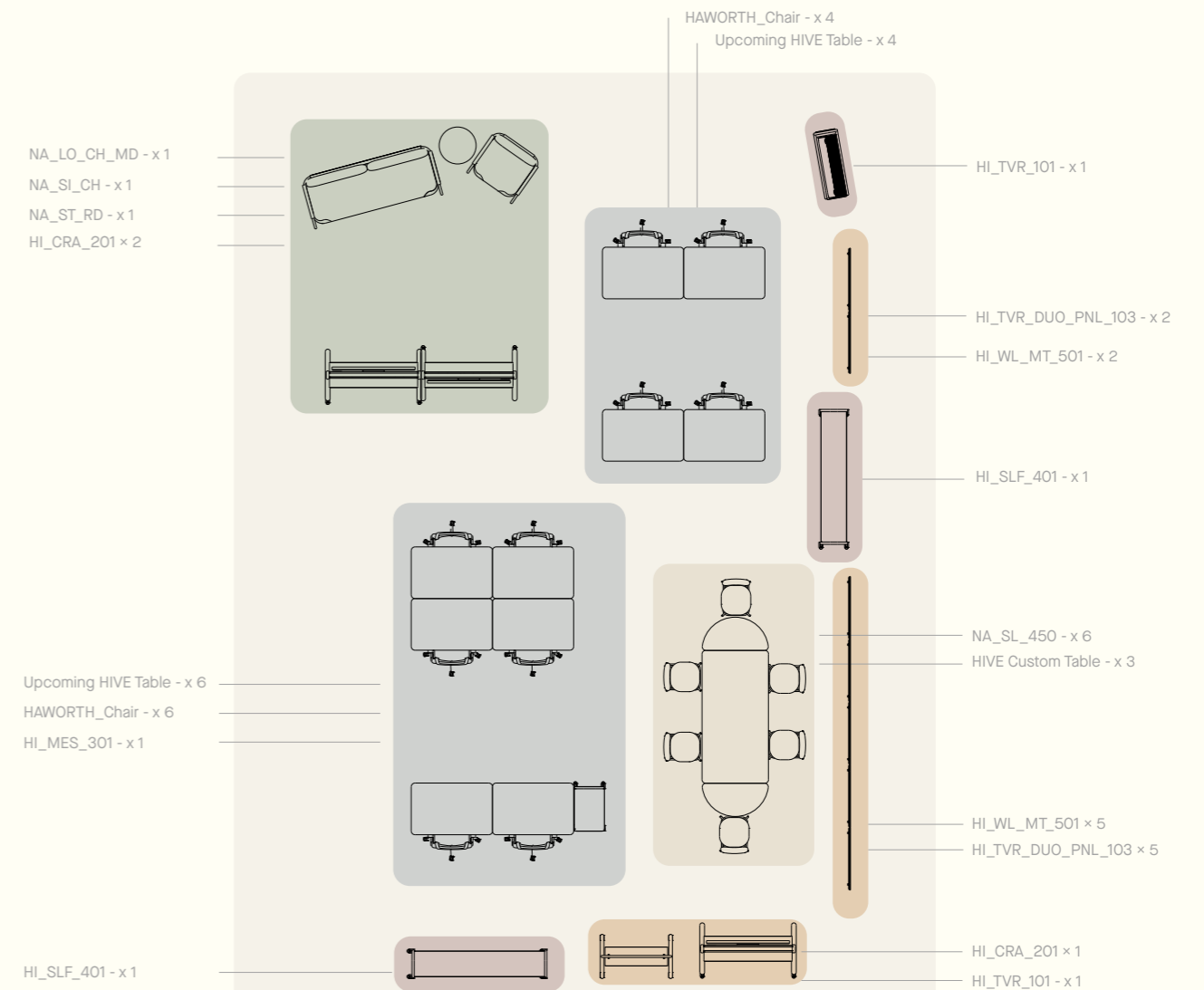

Casual Area



Isolated Work



Shared Workspace



Display / Presentation



Storage



## HIVE Sector - Creative

### HIVE SECTOR - CREATIVE

High collaboration and interaction. Creative teams practicing design thinking and consistent communication with high foot traffic.

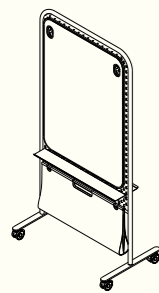

HIVE Traveller

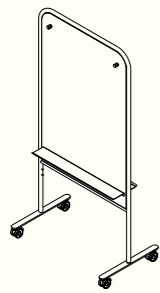

HIVE Canvas

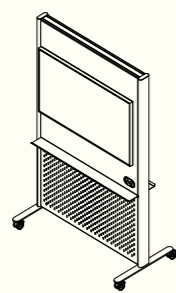

HIVE Creative



HIVE Messenger

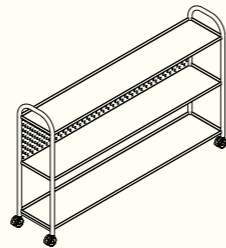

HIVE Mobile

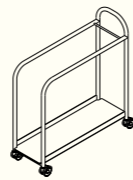

HIVE Traveller Trolley

### HIVE SECTOR - CREATIVE INDEX

#### Configuration Index

HI\_SLF\_401 - x 1

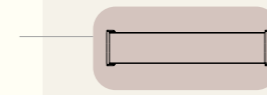

NA\_SL\_450 - x 6  
Custom HIVE table - x 2  
HI\_TVR\_101 x 1  
NA\_SL\_450 - x 4

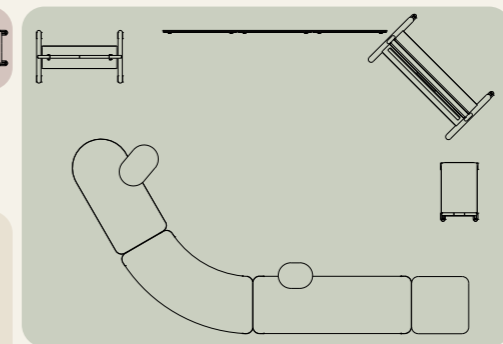
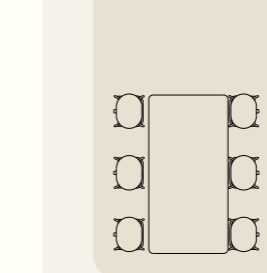

HI\_CRA\_201 - x 1  
HI\_TVR\_101 x 1  
HI\_MES\_301 - x 1  
HI\_WL\_MT\_501 x 3  
HI\_TVR\_DUO\_PNL\_103 x 3  
NA\_ST\_OV - x 1  
NA\_Mod\_Ottoman - x 5

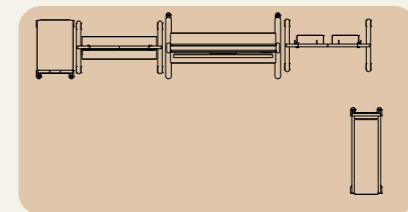

HI\_MES\_301 - x 1  
HI\_TVR\_101 - x 2  
HI\_CRA\_201 x 1  
HI\_TVR\_TRL\_102 - x 1

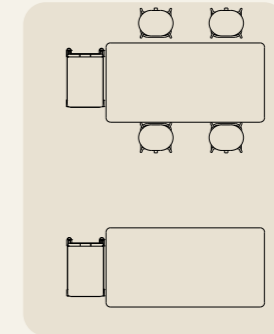

NA\_SL\_450 - x 4  
Upcoming HIVE table - x 2  
HI\_MES\_301 - x 2

HI\_WL\_MT\_501 x 4  
HI\_TVR\_DUO\_PNL\_103 x 4



HI\_TVR\_TRL\_102 - x 1  
HI\_SLF\_401 - x 1  
HI\_TVR\_101 - x 1



Casual Area



Isolated Work



Shared Workspace



Display / Presentation



Storage

## HIVE Sector - Education

### HIVE SECTOR - EDUCATION

High traffic, agile methodologies with constantly changing user groups and workspaces.

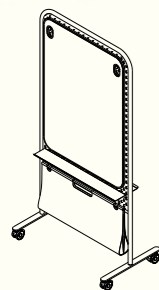

HIVE Traveller

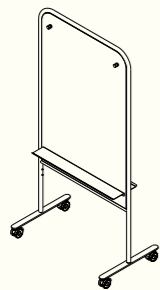

HIVE Canvas

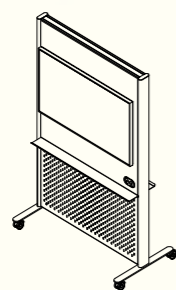

HIVE Creative



HIVE Messenger

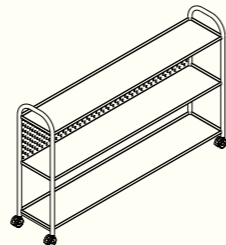

HIVE Mobile

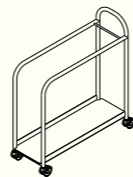

HIVE Traveller Trolley

### HIVE SECTOR - EDUCATION INDEX

#### Configuration Index

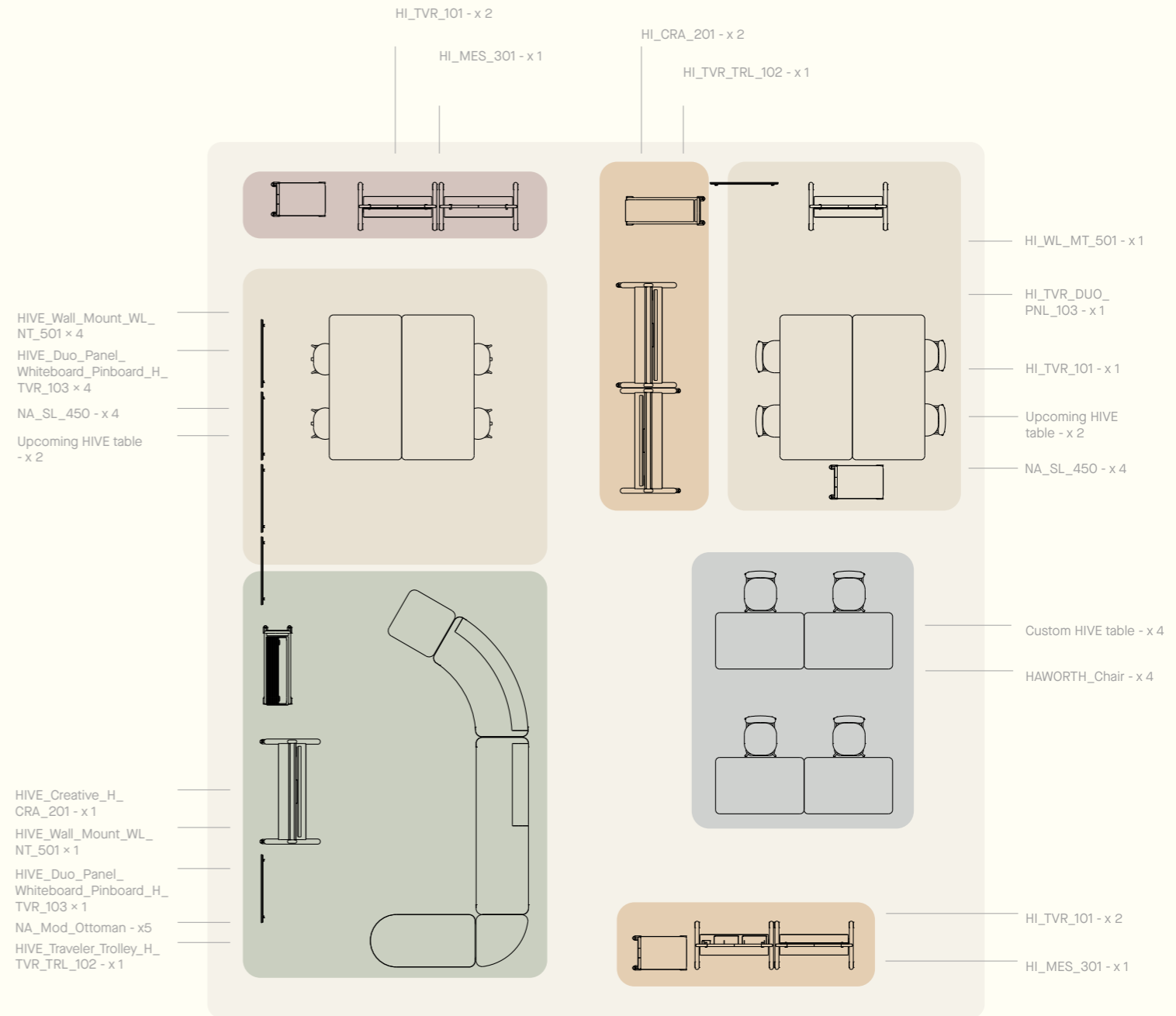

Casual Area



Isolated Work

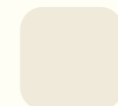

Shared Workspace



Display / Presentation



Storage

# HIVE Collection

## HIVE PRODUCTS

HIVE TRAVELLER CODE: HI_TVR_101 980mm W / 600mm D / 2000mm H	HIVE CANVAS CODE: HI_CAN_601 980mm W / 600mm D / 2000mm H	HIVE CREATIVE CODE: HI_CRA_201 1300mm W / 750mm D / 2000mm H	HIVE MESSENGER CODE: HI_MES_301 610mm W / 410mm D / 850mm H	HIVE MOBILE SHELF CODE: HI_SLF_401 1840mm W / 390mm D / 1150mm H
---	--	---	--	---

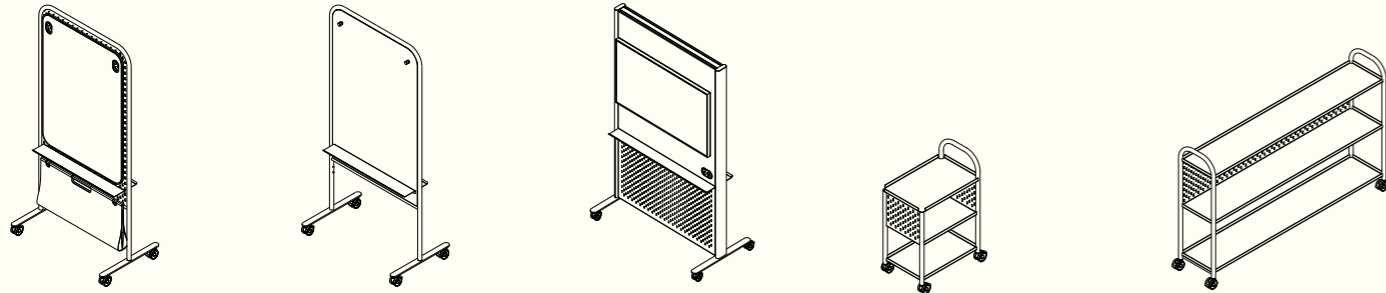

## HIVE PRODUCTS AND ACCESSORIES

HIVE TRAVELLER TROLLEY CODE: HI_TVR_TRL_102 1010mm W / 330mm D / 830mm H	HIVE WALL MOUNT CODE: HI_WL_MT_501 850mm W / 35mm D / 55mm H	HIVE TRAVELLER DUO PANEL CODE: HI_TVR_DUO_PNL_103 850mm W / 15mm D / 1190mm H	HIVE TRAVELLER LIGHTWEIGHT WHITEBOARD CODE: HI_TRV_LW_WB_105 850mm W / 3.2mm D / 1190mm H	HIVE CANVAS WHITEBOARD CODE: HI_CAN_WB_602 1378mm H / 885mm W / 1mm D
---	---	--	---	---

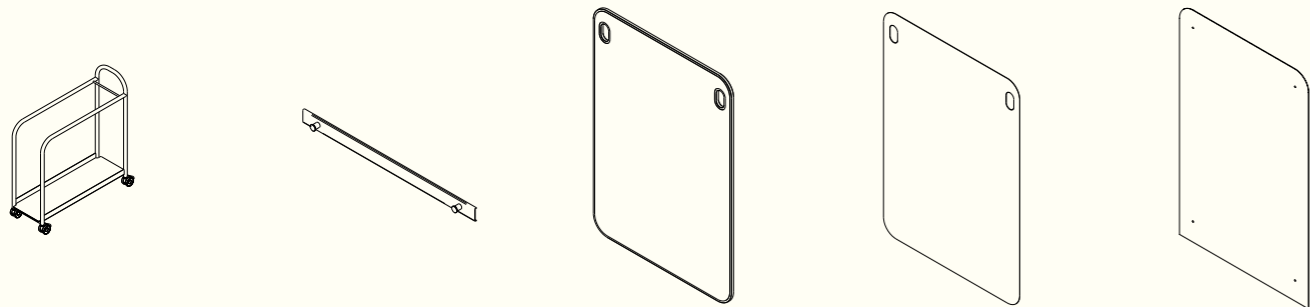

## HIVE ACCESSORIES

HIVE LOW TUB CODE: HI_LW_TB_701 300mm W / 115mm D / 40mm H	HIVE PEN HOLDER CODE: HI_PN_HLD_702 100mm W / 60mm D / 80mm H	HIVE POWER TUB CODE: HI_PWR_TB_703 152mm W / 42mm D / 140mm H	HIVE HOOK CODE: HI_HK_801 50mm W / 54mm D / 20mm H	HIVE TRAVELLER SHELF CODE: HI_TVR_SLF_104 850mm W / 130mm D / 40mm H	HIVE TRAVELLER FABRIC BAG CODE: HI_TRV_FB_BG_105 850mm W / 20mm D / 430mm H
---	--	--	---	---	--

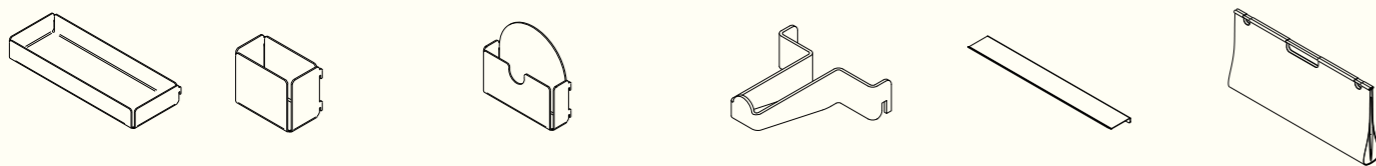

## MATERIAL

### HIVE Products

#### HIVE Frames

Made from furniture grade ERW steel tube. Rolled and hand welded to form a sturdy frame. Powder coated with TENTE Swivel Brake Castors

#### Castors

TENTE swivel castor with locking mechanism.

### HIVE Accessories

#### Fabric Bag

Looped INSTYLE Ecooustic felt fabric joined with 9mm steel rod.

#### Traveller Shelf

Sheet steel with multiple powder coated finishes available.

#### Traveller Hanging Pins

Machined Steel hanging pins that attach to the HIVE Traveller. Allows HIVE writing surface attachment.

### HIVE Traveller Accessories

#### Low Tub / Pen Holder / Power Tub / Hook

Sheet steel with multiple powder coated finishes available.

#### Traveller Duo Panel

An INSTYLE acoustic panel sitting within powder coated sheet steel covered with a writing surface film to create a reusable surface.

#### Traveller Lightweight Whiteboard

Non magnetic lightweight core that is covered with a writing surface film to create a reusable writing surface.

## MODULAR POWER

CMS freedom power allowing for stackable power charging at 78W. Not sourced through SkeeHan - available through CMS.

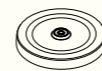

CMS Freedom Power - Base



CMS Freedom Power - Module

## RECOMMENDATIONS

We recommend the following products for use with the collection - not sourced through SkeeHan.

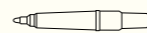

Pilot V Board Master

MADE IN AUSTRALIA.  
8 WEEK LEAD TIME.  
5 YEAR STRUCTURAL WARRANTY.





# HAN

[HANFURNITURE.COM.AU](http://HANFURNITURE.COM.AU)

02 6230 3637  
9/285 CANBERRA AVE,  
FYSHWICK ACT 2609

[@HANFURNITURESTUDIO](https://www.instagram.com/HANFURNITURESTUDIO)  
[HELLO@HANFURNITURE.COM.AU](mailto:HELLO@HANFURNITURE.COM.AU)

DESIGNED BY SKEEHAN STUDIO  
[SKEEHAN.COM.AU](http://SKEEHAN.COM.AU)